

OPERATIONS MANUAL



Table of Contents

		Page
Step 1	Start-Up & Programming	3
Step 2	Operation	13
Step 3	Maintenance	16
Step 4	Warranty	17

1

Recommended Start-Up Procedures

A

- Check each Variable Frequency Drive (VFD) to make sure the HP and voltage rating matches the fan motor.
- Check each Variable Frequency Drive for proper input and output connections.
- Verify each Variable Frequency Drive has separate conduit for the input and output wiring.

B

- Check the I/O Processor for proper input and output connections.
- Check inside the I/O Processor to verify the voltage select switch is set to the proper voltage.
- Check inside the I/O Processor to verify the power switch is turned on and the LED illuminated.

C

- Check the cable connections for each hood to make sure they are secured to the correct receptacles.
- Apply power to the Variable Frequency Drives and I/O Processor by turning on the respective breakers.
- Press the Light and Fan switches on the Keypad to verify the hood lights and fans turn on.

Keypad

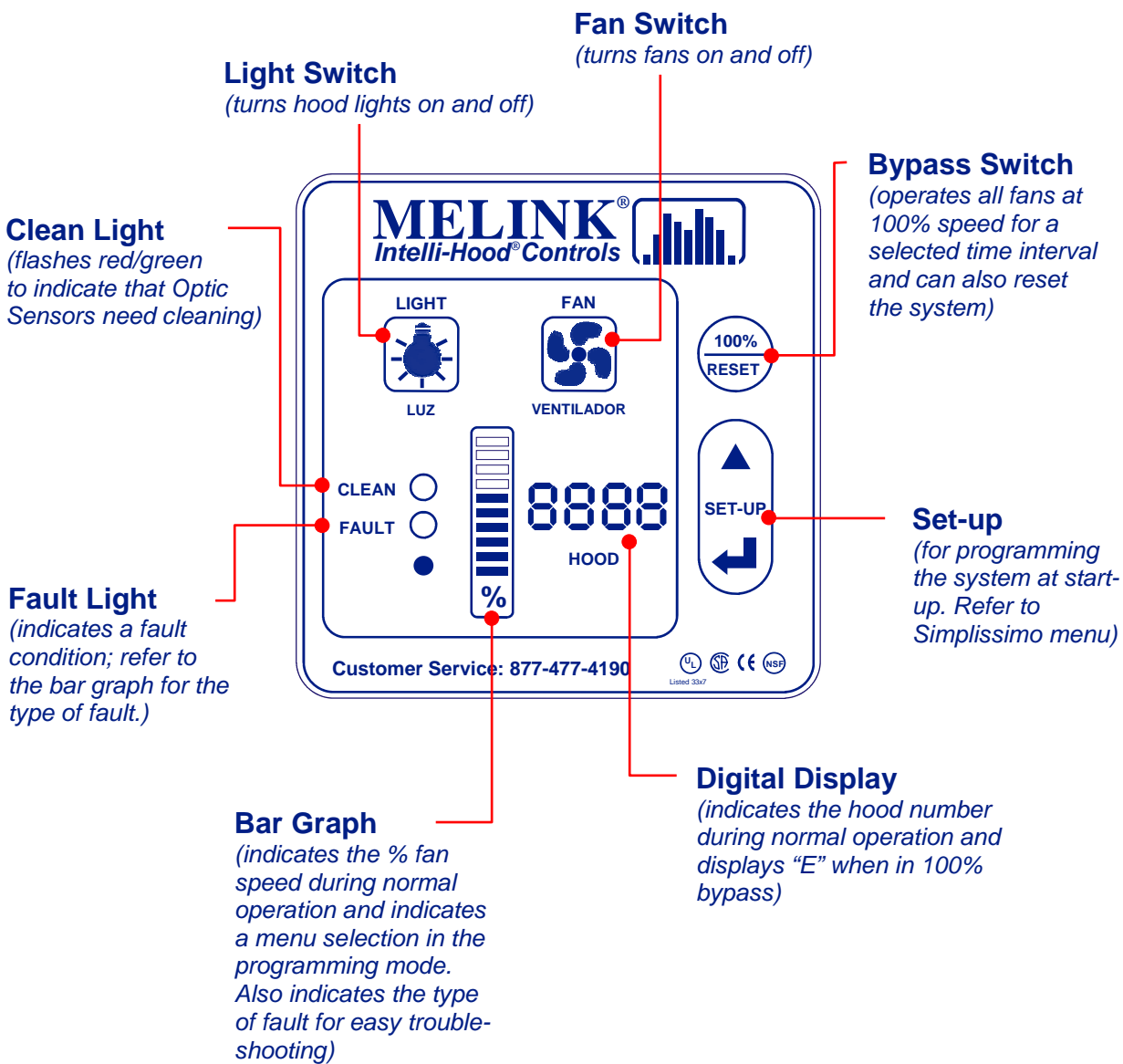

Keypad Start-Up

A

Press Light Switch

The hood lights turn on.



B

Press Fan Switch

The hood fans turn on.

Check the lights and displays on the Keypad:

1. Check the CLEAN light. If it flashes red and green, then proceed to Programming to perform the "Optics Alignment" check.
2. Check the FAULT light. If it is illuminated red, then recheck all cable connections, and proceed to Programming to set up Sensors and VFDs for each hood.

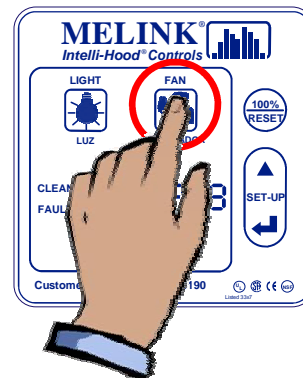

C

Check Fan Operation

Go to the roof and check fan operation:

1. Verify the fans are operating, because you may not be able to hear them inside the kitchen if they are running at minimum speed.
2. At the same time, verify correct rotation for every fan being controlled. If not correct, switch two of the three motor leads at the VFD.

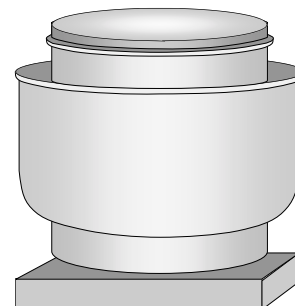

Keypad Start-Up

D

Press 100% Switch

Press the 100% / RESET Switch to operate the fans at full speed.

Let the fans run at full speed for about 30 minutes to verify that the VFD does not trip out on overload.

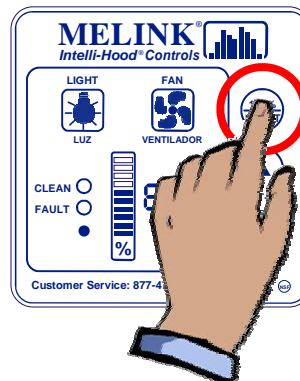

E

Program the Controls

You are now ready to program the Intelli-Hood controls using the SET-UP switches on the Keypad.

Refer to the Keypad Lock-Out Feature on page 8 in order to gain access to the Simplissimo Menu shown on the next page.

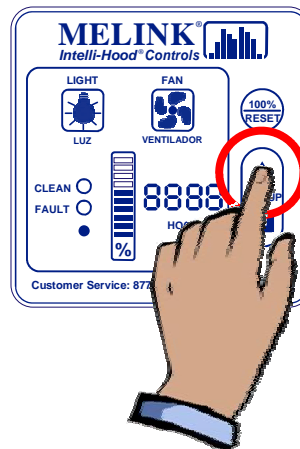

Programming

A

Set-Up Mode

To enter SET-UP mode, press both the SELECT switch and the ENTER switch and hold for 15 seconds. When SET-UP mode is accessed, the Keypad will beep three times.

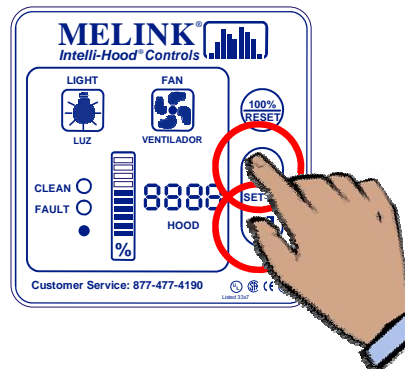

B

To Edit Programming

1. After entering SET-UP mode, the Keypad will beep three times; if the system is unlocked, the first 7-segment display will show **-H1-**. If an **L** is shown, unlock system as shown on page 6.
2. Pressing the SELECT switch will change the **-H1-** to a **-H2-** ; pressing the SELECT switch again will change the **-H2-** to a **-H3-** , and so on. Scroll to the desired hood number. The FANS switch may be used to scroll in reverse (The sequence will be: **-H1-** , **-H2-** , **-H3-** , **-H4-** , **-SY-** , **-UF-** , **CAL-**).
3. Pressing ENTER will move the hood number to the first and second 7-segment displays. The third and fourth 7-segment displays will start with a flashing 01 to signify the parameter number, with the bar graph showing the current setting.
4. Pressing the SELECT switch will scroll to subsequent numbers, moving forward through the parameters. The FANS switch may be used to scroll in reverse.
5. Pressing ENTER makes the third and fourth 7-segment displays solid and the LED in the bar graph will start flashing.
6. Pressing the SELECT or FANS switches will scroll up and down the bar graph. When the desired setting is reached, pressing the ENTER switch will confirm the setting and make the bar graph LED solid (and the third and fourth 7-segment displays will begin blinking again).
7. To exit the hood menu, press the 100% / RESET switch.
8. To exit the SET-UP mode completely, press the 100% / RESET switch again.
9. The Keypad will go back to normal display mode.

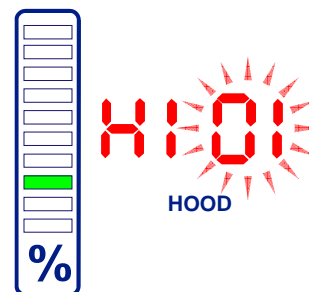
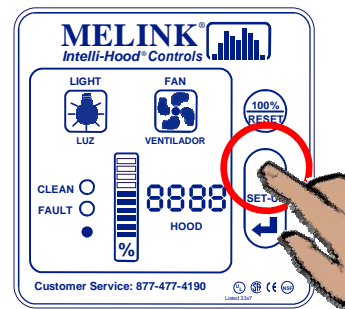

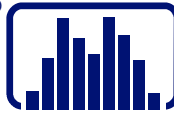

STEP

1

Programming

To Lock Programming

Press and hold the both the SELECT switch and the ENTER switch for 15 seconds. An **-H1-** will show on the 4-digit display and the Keypad will beep three times.

Press and hold the both the SELECT switch and the ENTER switch for 15 seconds. An **L** will show on the 4-digit display and the Keypad will beep one time.

Press 100% / RESET to exit SET-UP mode.

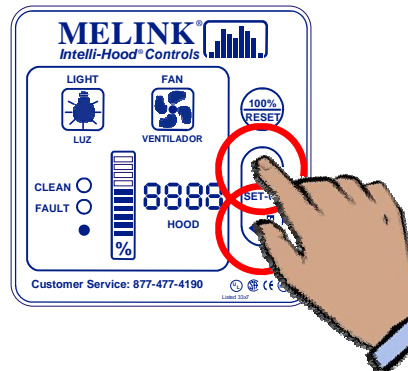

To Unlock Programming

Press and hold the both the SELECT switch and the ENTER switch for 15 seconds. An **L** (non-flashing) will show on the 4-digit display and the Keypad will beep three times.

Press and hold the both the SELECT switch and the ENTER switch for 15 seconds. An **-H1-** will show on the 4-digit display and the Keypad will beep one time.

Press 100% / RESET to exit SET-UP mode.

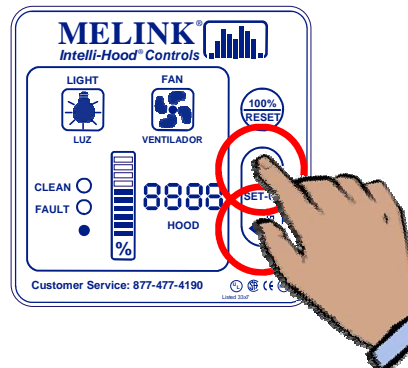

Intelli-Hood Features & Options

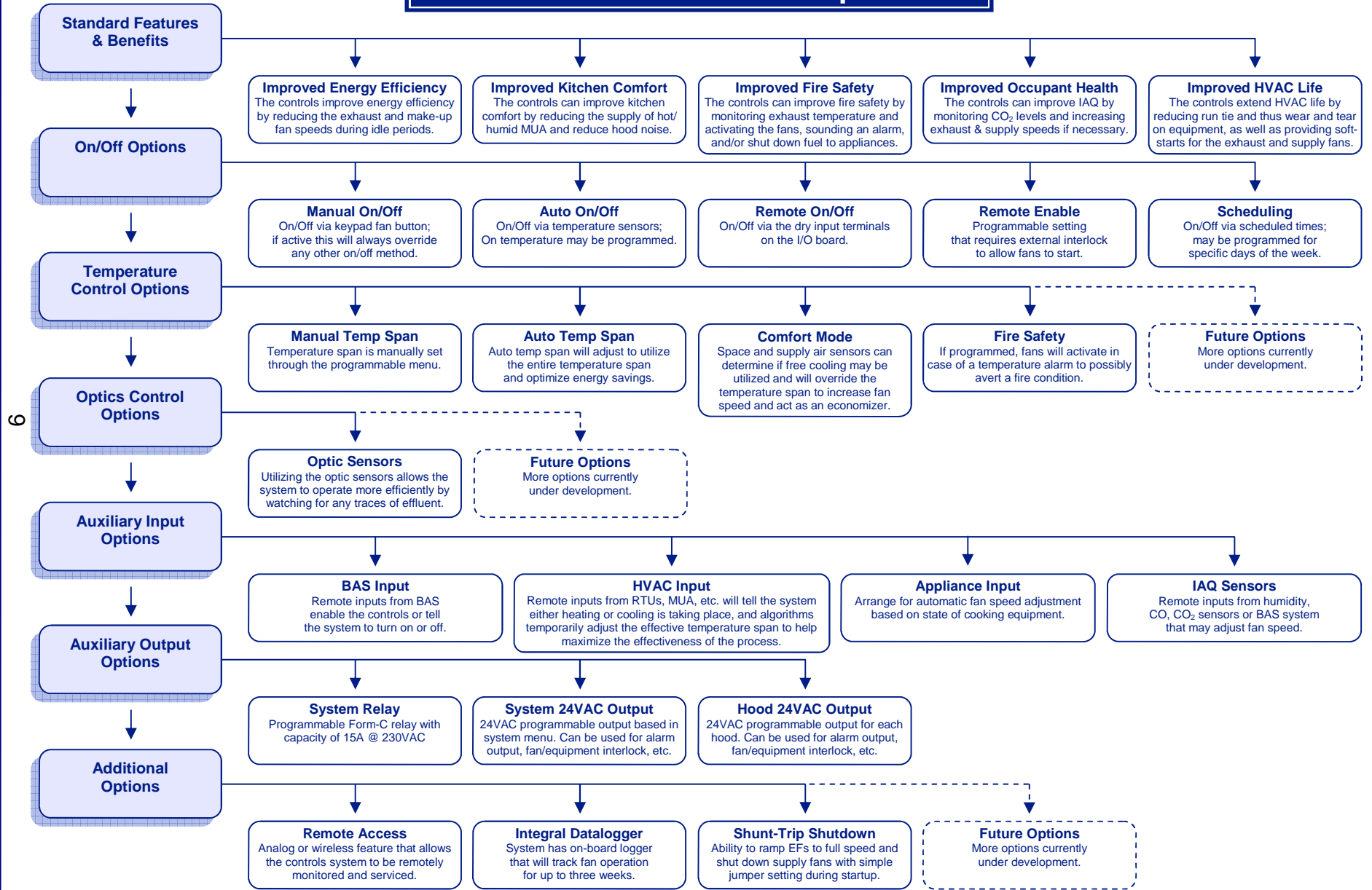

Programming: *Simplissimo*

HOOD MENU

Basic Settings

(Defaults in Red)

	01	02	03	04	05	06	07	08	09	10
Bar Graph	Exhaust Temp Span	Min. Fan Speed	Max. Fan Speed	Exhaust Temp. Alarm	Hood 24VAC Output	No. Hood Sensors	Auto On/Off	VFD Address	Add. VFD Address	Short-Cycle Ratio
10	70-85F	Auto	100%	FLASH AUD350F	24/7	No Sensors				
9	70-80F	90%	95%	FLASH AUD300F	Fault	10	See Scheduling in System Menu		No Add. VFD	
8	Auto TempSpan	80%	90%	FLASH AUD250F	Mom Rel	4T/10			15&16	80%
7	75-150	70%	85%	FLASH AUD200F	MUA Cool	3T/10			13&14	70%
6	75-140	60%	80%	FLASH AUD150F	MUA Heat	2T/10	Heat-20%		11&12	60%
5	75-130	50%	75%	FLASH 350F	MUA Damper	1T/10	Heat-15%	No VFD	9&10	50%
4	75-120	40%	70%	FLASH 300F	Fans On	4T	Heat-10%	4	8	40%
3	75-110	30%	65%	FLASH 250F	Smoke	3T	Heat-5%	3	7	30%
2	75-100	20%	60%	FLASH 200F	Exhaust Temp	2T	Heat-0%	2	6	20%
1	75-90	10%	55%	FLASH 150F	No	1T	No	1	5	No

Advanced Settings

	11	12	13	14	15	16	17	18	19
Bar Graph	Hood Relay Input (Dry)	Relay Inputs to Utilize	Optic Sensor Address*	Scheduling	Temp Span Min	Auto. On/Off Temp.	CFM Ratio for MUA/AUX Output	Cable Length	VFD Software
10	T-Stat & 90%						None	Enter cable length	
9	T-Stat & 80%					95F/80F	9		
8	T-Stat & 75%	None		Sched. 1, 2, 3		90F/80F	8		
7	T-Stat & 70%	System 1, 2		Sched. 1, 3		85F/80F	7		
6	T-Stat & 60%	Hood & System 2		Sched. 2, 3		95F/75F	6		IMO PC
5	T-Stat & 50%	Hood & System 1		Sched. 1, 2	85F	90F/75F	5		Control Tech
4	100% on Closure	System 2	Hood 4	Sched. 3 Only	80F	85F/75F	4		ABB
3	Rem Enable	System 1	Hood 3	Sched. 2 Only	75F	80F/70F	3		Delta
2	Rem On/Off	Hood & System 1,2	Hood 2	Sched. 1 Only	70F	75F/70F	2		GE
1	No	Hood Only	Hood 1	No	65F	70F/70F	1		A-B

Programming: *Simplissimo*

SYSTEM MENU

(Defaults in Red)

	9-01	9-02	9-03	9-04	9-05	9-06	9-07	9-08	9-09	9-10
Bar Graph	4-20mA/ 0-10vdc Aux Out	4-20mA Aux In	Optics Hang Time	System Relay Input 1 (Dry)	System Relay Input 2 (Dry)	Bypass Timer	Comfort Mode Sensors	Misc.	System 24VAC Output	Optics Alignment Check
10				T-Stat&90%	T-Stat &90%	4 Hrs			24/7	
9	Ext In			T-Stat&80%	T-Stat &80%	3 Hrs			Fault	
8	VFD Address 4			T-Stat&75%	T-Stat &75%	2 Hrs		ConvCool/ WinSB/IB	Mom Rel	
7	VFD Address 3	Aux Avg	180 Sec	T-Stat&70%	T-Stat &70%	1 Hr		Conv Cool/ Int Bar	MUA Cool	
6	VFD Address 2	Aux Sub	90 Sec	T-Stat&60%	T-Stat &60%	45 Min		Win SB/Int Bar	MUA Heat	
5	VFD Address 1	Aux Add	60 Sec	T-Stat&50%	T-Stat &50%	30 Min		Conv Cool Only	MUA Damper	Exit
4	Lowest	Average	25 Sec	100% on Closure	100% on Closure	15 Min	Econo + Auto	Win SB Only	Fans On	Hood 4
3	Highest	Subtract	15 Sec	Rem Enable	Rem Enable	10 Min	Auto Span	Int Bar	Smoke	Hood 3
2	Average	Add	10 Sec	Rem On/Off	Rem On/Off	5 Min	Economizer	Conv Cool/ Win SB	Exhaust Temp	Hood 2
1	No	No	5 Sec	No	No	No	No	No	No	Hood 1

	9-11	9-12	9-13	9-14	9-15	9-16	9-17	9-18	9-19	9-20
Bar Graph	NO/NC Relay 15A @230VAC	Time Set	Schedule 1 Active Days	Schedule 1 Start	Schedule 1 Duration Time	Schedule 1 Options	Schedule 2 Active Days	Schedule 2 Start	Schedule 2 Duration Time	Schedule 2 Options
10		Enter time/ date		Enter time of day	5 hrs			Enter time of day	5 hrs	
9	Fault				4.5 hrs				4.5 hrs	
8	Mom Rel		Sun-Mon		4 hrs		Sun-Thurs		4 hrs	
7	MUA Cool		Sat-Sun		3.5 hrs		Sat-Sun		3.5 hrs	
6	MUA Heat		Fri-Sun		3 hrs		Fri-Sun		3 hrs	
5	MUA Damper		Fri-Sat		2.5 hrs		Fri-Sat		2.5 hrs	
4	Fans On		Mon-Thurs		2 hrs	On/Off Sched	Mon-Thurs		2 hrs	On/Off Sched
3	Smoke		Mon-Fri		1.5 hr	100% Sched	Mon-Fri		1.5 hr	100% Sched
2	Exhaust Temp		All		1 hr	100% If On	All		1 hr	100% If On
1	No		None		0.5 hr	Not Used	None		0.5 hr	Not Used

Continued

Programming: *Simplissimo*

SYSTEM MENU

(Defaults in Red)

	9-21	9-22	9-23	9-24	9-25	9-26	9-27	9-28	9-29	9-30
Bar Graph	Schedule 3 Active Days	Schedule 3 Start	Schedule 3 Duration Time	Schedule 3 Options	Keypad Function Disable	Cmft. Mode Space Temp	Cmft. Mode Supply Temp	MUA Heat If Kitchen <	MUA Heat If Supply <	MUA Cool If Kitchen >
10		Enter time of day	20 hrs			77		74F		80F
9			18 hrs			76		73F	65F	79F
8	Sun-Thurs		16 hrs		Byp+Lights	75	72	72F	63F	78F
7	Sat-Sun		14 hrs		Fans+Byp	74	71	71F	60F	77F
6	Fri-Sun		12 hrs		Fans+Lights	73	70	70F	58F	76F
5	Fri-Sat		10 hrs		Bypass	72	69	69F	55F	75F
4	Mon-Thurs		8 hrs	On/Off Sched	Lights	71	68	68F	53F	74F
3	Mon-Fri		6 hrs	100% Sched	Fans	70	67	67F	50F	73F
2	All		4 hrs	100% If On	All	69	66	66F	48F	72F
1	None		2 hrs	Not Used	No	68	Tk>To	65F	45F	71F

	9-31	9-32	9-33	9-34	9-35	9-36	9-37	9-38	9-39	9-40
Bar Graph	Add. MUA Address	AUX VFD Software	Gain for AUX Input	Modem Options	Data Log Sample Rate	US / SI Units Selection	Day On/Day Off Monitoring	Smoke Density	Fire Safety	Full Speed @ Start
10			150%							
9			140%							
8			130%							
7			120%		5 min					
6	31,32,33	IMO PC	110%		3 min					5 Min.
5	31,32	Control Tech	100%		2 min					4 Min.
4	33	ABB	90%	Wireless	1 min	24H Degrees C		Proportional		3 Min.
3	32	Delta	80%	9+Auto-Dial	30 sec	12H Degrees C		Heavy	All Hoods	2 Min.
2	31	GE	70%	Auto-Dial	10 sec	24H Degrees F	Active	Medium	Alarm Hood Only	1 Min.
1	No	A-B	60%	No	No	12H Degrees F	Disabled	Light	No	No

Sequence of Operation

A

Press Light Switch

The hood lights turn on.

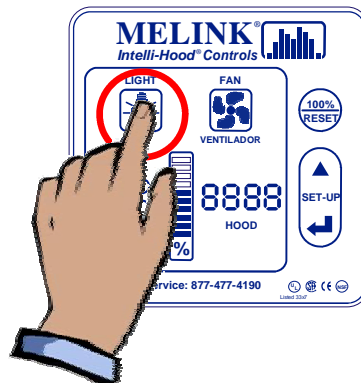

B

Press Fan Switch

The hood fans turn on. Fan speed automatically varies with the heat/smoke load generated by the cooking appliances. This reduces hood noise, improves kitchen comfort, and saves energy. The bar graph on the Keypad indicates the fan speed for each hood.

If the CLEAN light flashes red and green, clean the lenses on the Optic Sensors.

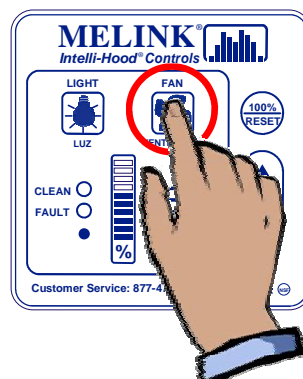

C

Press 100% Switch In Case of Emergency

The fans can be operated at full speed like a conventional hood system by pressing the 100% / RESET button. This should only be used if there is noticeable smoke loss and the fans are not already running at full speed. Upon pressing this button, the bar graph will flash 100% speed and the letter "E" will be displayed with each hood designation. After the preset period of time, the fan speed will return to its previous operation mode.

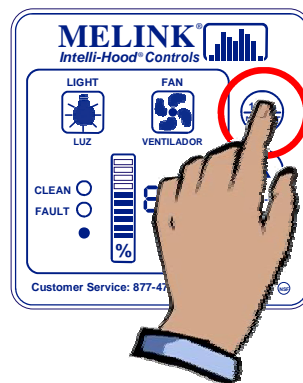

How it Works

D

Heat Detection

If the appliances are not turned on, the fan will operate at a minimum speed of 10-50%. Once the appliances are turned on, the fan speed will increase as the exhaust air temperature increases. This normally results in the fan speed increasing to 50-80%.

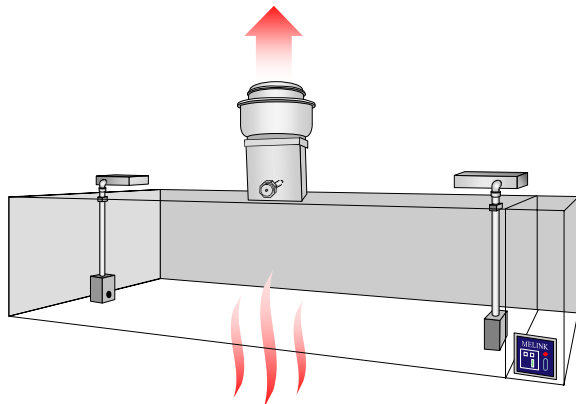
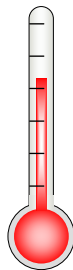

E

Smoke Detection

Upon detection of smoke during cooking, the Optic Sensors will bypass the Temperature Sensor and increase the fan speeds to 100%. This ensures the proper removal of smoke as well as compliance with codes that require a minimum air volume and duct air velocity. Once the smoke is removed, the fan speed will decrease based on the exhaust air temperature.

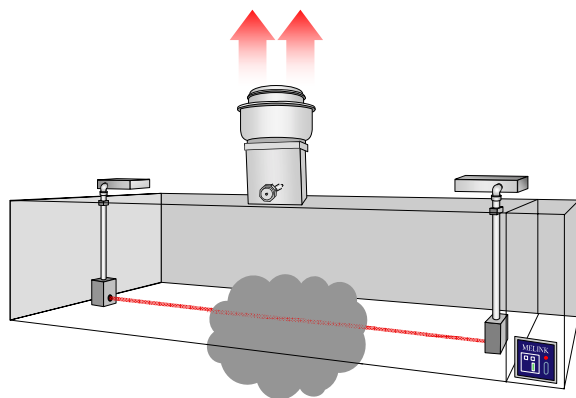

F

Quiet Hood Operation

The hoods will sound very quiet when the fans are operating at minimum speed. It may sound like the hood is turned off until the fan speed increases above 50% with the heat and/or smoke load.

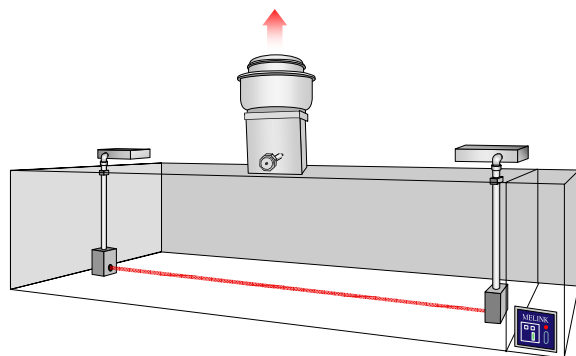
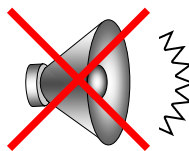

NOTE: Hoods sound very quiet at lower fan speeds.

How it Works

G

View Current Hood Exhaust Rates

During normal operation, the Keypad bar graph will indicate the percent fan speed of each hood. The digital display will continually scroll through each hood connected to the system every 5 seconds.

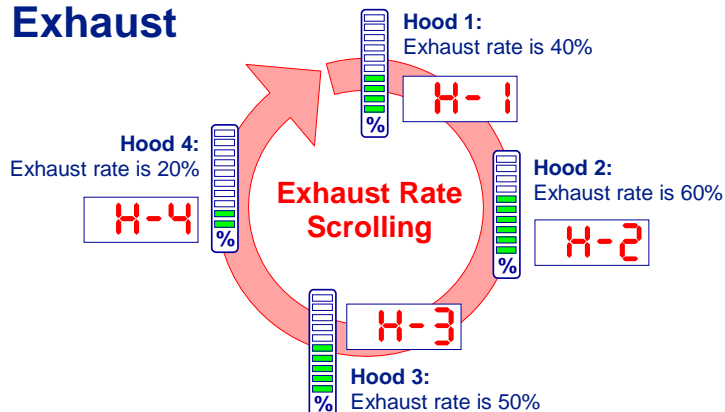

H

View Current Exhaust Temps & Average VFD

To view the exhaust temperatures and average VFD speeds for each hood, press the selection switch one time. The exhaust temperature will be shown in the digital display, and the VFD speeds will be shown in the bar graph. It will scroll through only once, then return to showing the percent fan speeds.

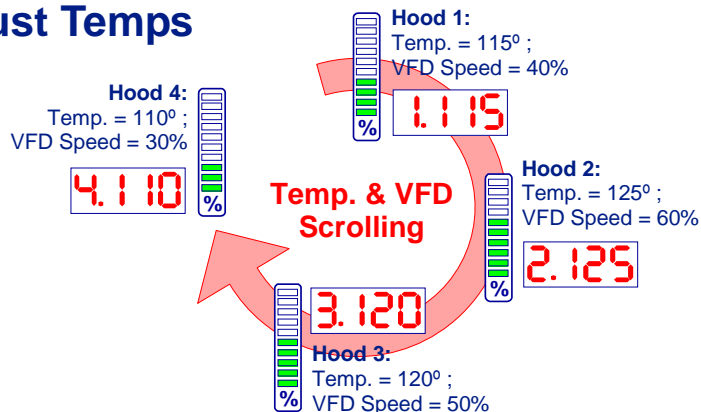

I

View Time

To view the time, press the Enter key. The digital display will first show the hour and then the time of day and date. It will show this only once, then it will return to the previ-

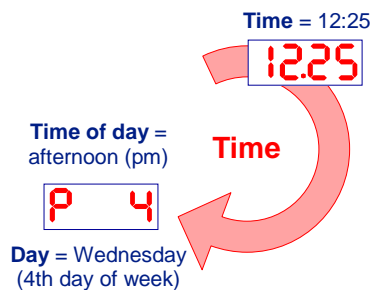

Maintenance

A

Optic Sensors

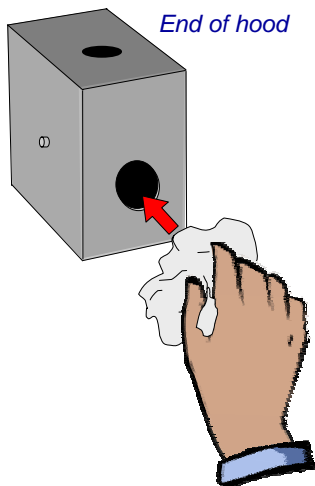

If the “Clean” indicator light on the Keypad begins to flash from red to green, the optic lenses need cleaning.

First, wipe off the lenses on each end of the hood with a clean, soft cloth. Press the fan switch off and then on again to initiate automatic calibration of the Optic Sensors now that they have clean lenses. The indicator light should turn green within about five seconds to confirm calibration.

IMPORTANT: Advise your hood/duct cleaner not to spray hot water or steam into the photo housings so that the Receiver and Emitter do not get wet. The photo housings should be covered to ensure protection of these devices.

B

Temperatures Sensors

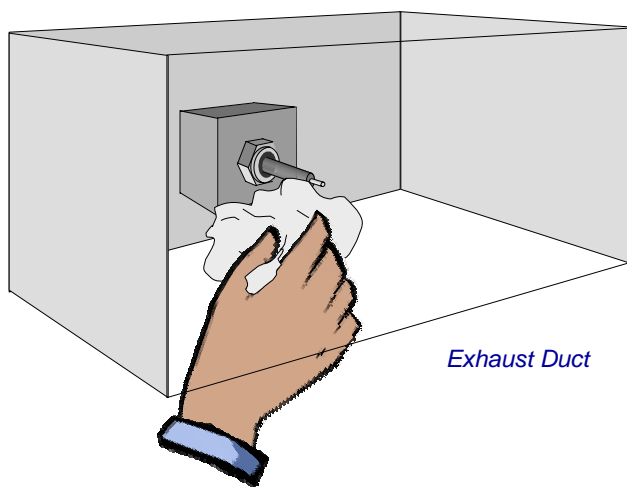

Clean the temperature sensors at least once a year or as needed by simply wiping off any grease with a clean cloth. This will ensure the sensors respond quickly to any change in exhaust air temperature.

Warranty

Returns

No returns will be accepted without prior written approval from Melink Corporation. All returned shipments must be prepaid and are subject to handling charges.

Damaged Shipments

Notify the carrier in the event of damaged shipments, whether they are apparent at the time of delivery or when unpacked. File a complaint with the carrier, as the customer is responsible for the collection of damage claims.

Warranty

To validate the warranty, complete and return the warranty validation form in the Owner's Manual. Complete one form for each system installed and send to Melink Corporation at the following address within 10 days:

Melink Intelli-Hood[®]
Attn: Warranty Validation
5140 River Valley Road
Milford, OH 45150

Melink Corporation extends this warranty to the original buyer and warrants that Melink products shall be free from original defects in workmanship and material for three years from date of shipment, provided same has been properly stored, installed, operated, maintained, and serviced. This warranty does not apply to products which have been altered or repaired without expressed written authorization from Melink Corporation, or altered or repaired in any way so as to affect its performance or its reliability, nor which have been subjected to misuse, negligence or accident. The buyer assumes responsibility for all risks and liabilities resulting from the use of these products.

Melink Corporation is not responsible for the cost of removal of the defective product or part, damages due to removal, or any expenses incurred in shipping the product or part to or from the plant, or the installation of the repaired or replaced product or part.

STEP

4

Warranty

Please complete this form and fax to Melink at (513) 527-7023, or send by mail to:
Melink Corporation, 5140 River Valley Road, Milford, OH 45150.

Owner _____ Date _____

Company _____

Address _____

City _____ State _____ Zip _____

Country _____

Phone _____ Fax _____

Email _____

MODEL _____ (located inside I/O Processor)

SERIAL NO. _____ (located inside I/O Processor)

Installer _____

Address _____

City _____ State _____ Zip _____

Phone _____

Date of Installation & Start-Up _____

Call Melink Customer Service at 513-965-7300 if you have any questions.

Please let us know how we can improve our Operations Manual.
We want your experience with our product to exceed all expectations.

